

MD60-020 Integrated Servo System



FEATURES

- 200 Watt
- 24-70VDC
- 60mm Frame Size
- 16 bit Magnetic Absolute Encoder
- 3000 RPM Rated Speed
- 0.64 Nm Rated Torque
- Modbus RTU or CANopen
- Position and Speed Control
- RS232 and RS485 Port



DESCRIPTION

The MD60-020 Integrated Servo System includes a 200 Watt Servo Motor, operated by the Servo Drive. Each system includes a Servo Motor ranging from a size of 60mm square, power rating of 200 Watts, with a Servo Drive attached to the top of the Servo Motor. These packages are ideal and provide easy start-ups, convenience, and performance. The Servo Motors included in these packages provide torque up to 1.92 Nm. The Servo Drive is designed to switch dynamically among different control methods for more flexible operation and can operate position control mode either with pulse and direction inputs, internal position points, or internal speed points.

Item	Rated Output Power (Watts)	Rated Voltage (VDC)	Rated Speed (RPM)	Rated Torque (Nm)	Rated Current (Arms)	Inertia (Kg-cm ²)	Peak Torque (Nm)	Max Speed (RPM)	Brake (24VDC)	Motor Length (mm)	Shaft Diameter (mm)
MD60-020-DMAK-LA-000	200	24-70	3000	0.64	5	0.214	1.92	4000	No	129.2	14
MD60-020-DMAK-CA-000	200	24-70	3000	0.64	5	0.214	1.92	4000	No	129.2	14

ORDERING INFORMATION

MD60-020-DMAK-LA-000

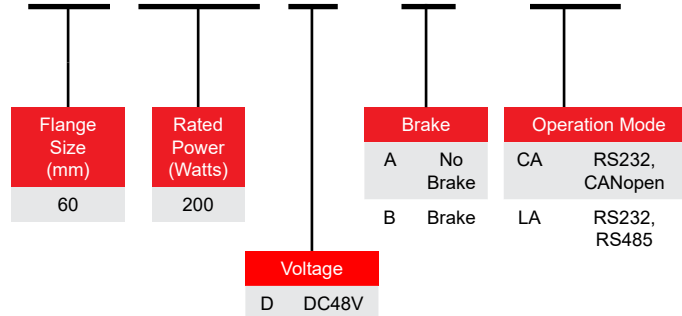

L011907

DIMENSIONS

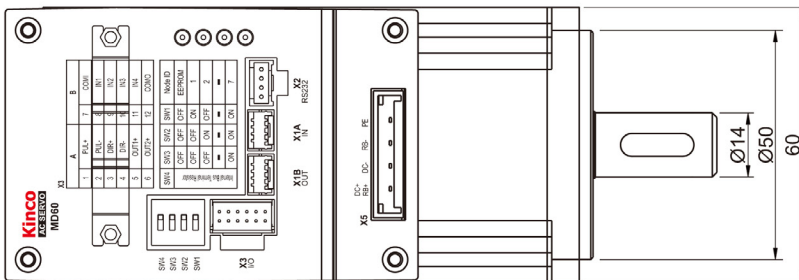
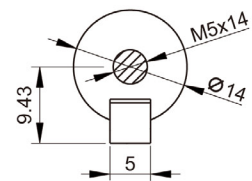
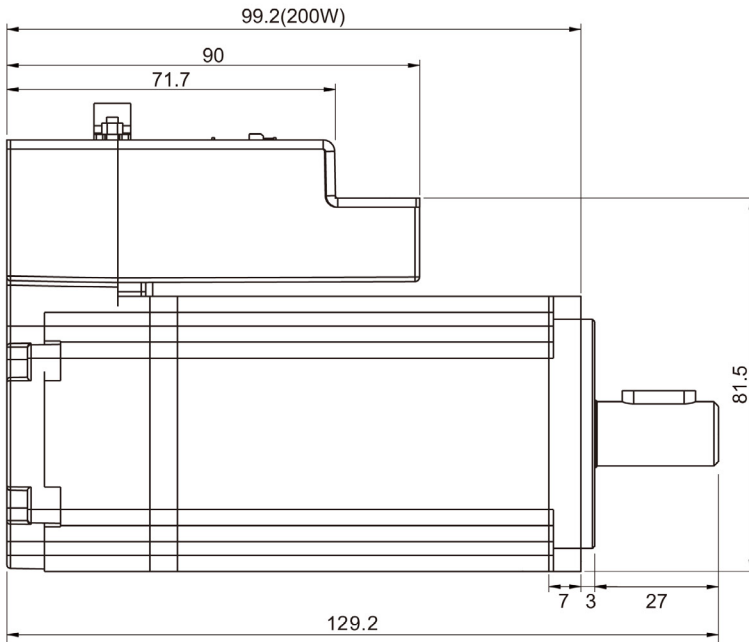
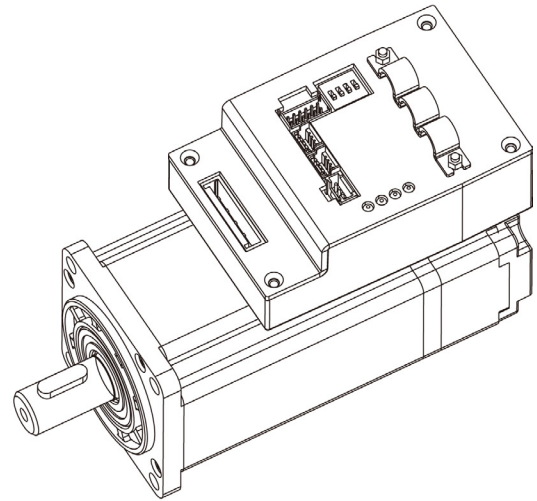
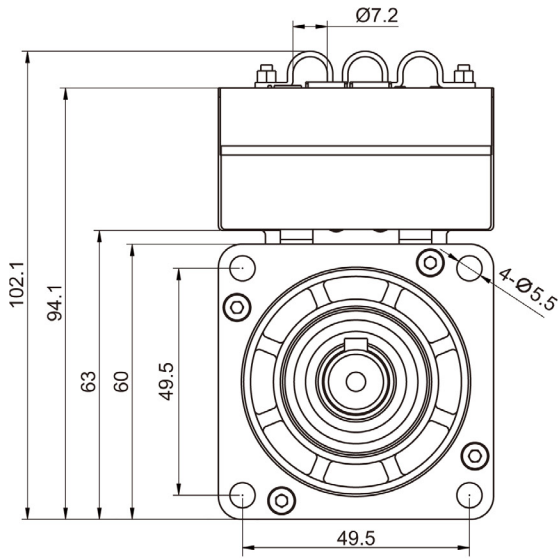

Dimensions are in mm

CAN BUS		or	RS485	
PIN	Signal		PIN	Signal
1	GND	1	GND	
2	GND	2	GND	
3	CAN_L	3	485+	
4	CAN_H	4	485-	

CAN BUS or RS485 Port — X1 — CAN BUS or RS485

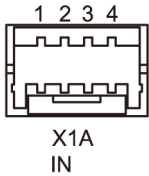
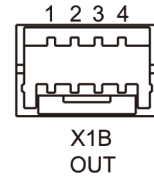

RS232 Port	
PIN Number	Signal
1	RX
2	TX
3	GND
4	GND

RS232 Communication Interface — X2 —

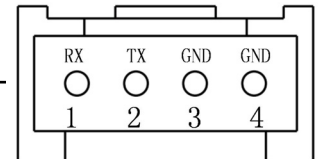

Digital Signal Input and Output Port

PIN No.	Signal	PIN No.	Signal
1	PUL+	7	COMI
2	PUL-	8	IN1
3	DIR+	9	IN2
4	DIR-	10	IN3
5	OUT1+	11	IN4
6	OUT2+ / BR+	12	COMO

Digital Input/Output Terminals — X3 —

X3 I/O

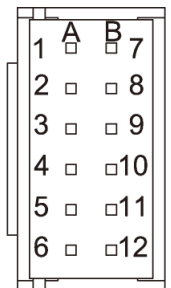

PUL+, PUL-, DIR+, DIR- Pulse signal input terminal
Input voltage: 3.3V~24V
Maximum Frequency

X3 OUT1+, OUT2+, COMO Digital signal output
Maximum output current: 100mA

IN1, IN2, IN3, IN4, COMI Digital signal input
High level: 12.5VDC-30VDC
Low level: 0VDC-5VDC
Input frequency: <1KHz

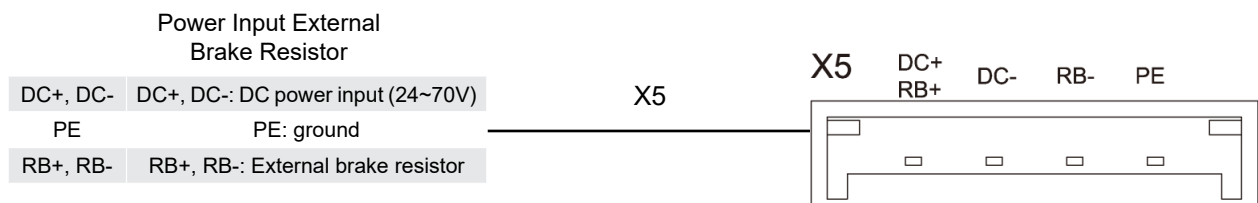

Model Parameter		MD60-020 Series
Power	Main Supply Voltage	DC24V~70V
Current	Rated Current (RMS)	5A
	Peak Current (PEAK)	21A
Feedback Signal		16 bit Single-Turn Magnetolectric Encoder
Brake Chopper		Via Wiring an External Braking Resistor (Mainly in Quick Start and Stop Application).
Brake Chopper Threshold		DC73V ± 2V (Default Value, Adjustable via Software)
Over-Voltage Alarming Threshold		DC83V ± 2V
Under-Voltage Alarming Threshold		DC18V ± 2V
Cooling Method		Natural Air Cooling
Input Specification		COMI Terminal for 4 Digital Inputs High Level: 12.5VDC~30VDC Low Level: 0VDC~5VDC Maximum Frequency: 1KHz 2 High Speed Digital Inputs Input Voltage: 3.3V~24V Maximum Frequency: 500KHz
Output Specification		COMO Terminal for 2 Digital Outputs Maximum Output Current: 100mA
Pulse Direction Output		Pulse + Direction, CCW+CW, Phase A+Phase B (5V~24V)
Brake		Built-in Brake Power Supply 24V Maximum Current 0.5A
RS232		Default Baudrate Setting is 38400, the Max. Baudrate is 115.2KHz, use Kinco Software to Communicate with PC, or via Free Protocol to Communicate with Controller.
RS485 / Modbus		The Max. Baudrate is 115.2KHz, use Modbus RTU Protocol to Communicate with Controller.
CAN BUS		Support Maximum 1MHz Baudrate. Communicate with Controller via CANopen Protocol
Mechanical Dimensions (mm) Note: Including Terminal Space		100x95x60
Weight (Kg)		1.2
Rated Speed (rpm)		3000
Rated Torque (Nm)		0.64
Maximum Torque (Nm)		1.92
Rotor Moment of Inertia (Kg-cm ²)		0.214

Operation Environment	Operating Temperature	0 ~ 40°C
	Storage Temperature	-10°C~70°C
	Humidity (Non-Condensing)	Below 90%RH
	Protection Class	IP20
	Installation Environment	Installed in a Dust-Free, Dry and Lockable Environment (Such as in a Electrical Cabinet)
	Installation Mode	Vertical Installation or Horizontal Installation
	Altitude	Rated Working Altitude at 1000m or Below, Above 1000m: Decreasing 1.5% per 100m Rise, Maximum Altitude 4000m
	Atmospheric Pressure	86kpa-106kpa